

Froebel Star

Contents of this Page

What is Froebel Star?

How to Make Froebel Star:

- [The Four Strips](#)
- [The First 2x2 Square](#)
- [The Second 2x2 Square](#)
- [The Eight Points](#)
- [The Eight Bags](#)

[Variants of Froebel Star](#)

[Froebel's Star on the Internet](#)

[References](#)

[Comments](#)

[To the Main Page](#)

"Mathematische Basteleien"

What is the Froebel Star?

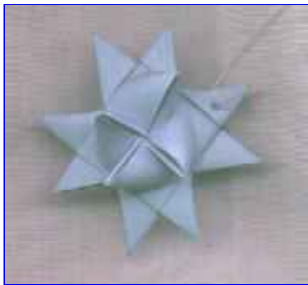

The Froebel star is a three-dimensional star made of four strips of paper.

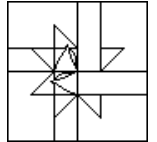

How to Make Froebel's Star in Five Steps

The Four Strips [top](#)

1

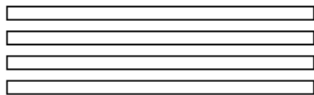

Cut out four strips of paper in size 1: 25 or better 1:30.

2



Fold the strips in the middle and cut the ends diagonally.

The First 2x2 Square [top](#)

3

Hold the first strip horizontally and hang the second strip over it.

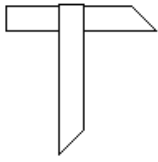

4

Wrap the third strip round the second.

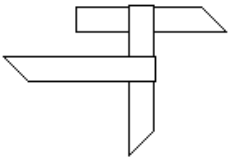

5

Wrap the fourth strip around the third and stick the ends of the fourth strip into the loop of the first strip.

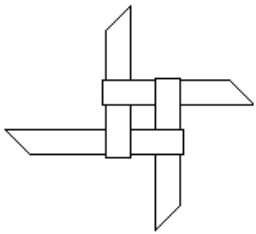

6

Pull the ends of the four strips until a square of four squares appears.

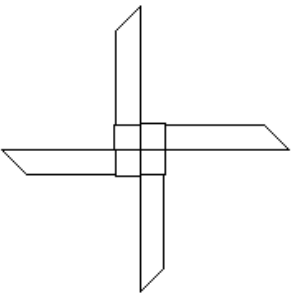

The Second 2x2 Square [top](#)

7

Fold the top left strip downwards.

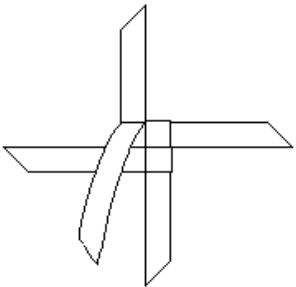

8

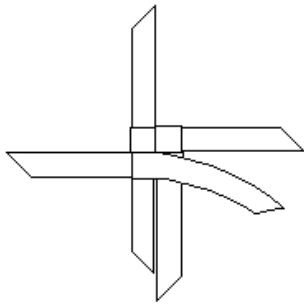

Fold the left strip to the right and put it upon the one just folded.

9

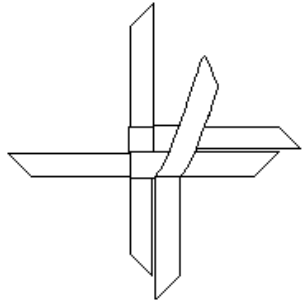

Fold the right strip upwards.

10

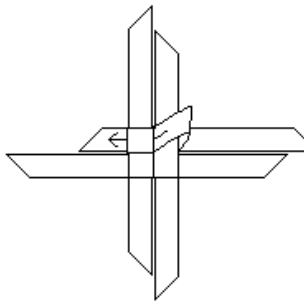

Fold the top left strip to the right and stick its end into the loop of the strip first folded (see 7).

11

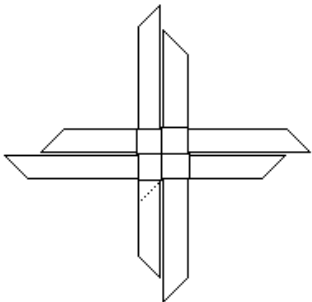

Pull the end to the right.

The Eight Points [top](#)

12

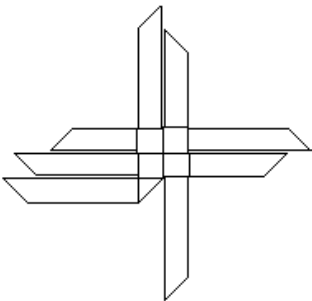

Fold the left strip with a turn through 90 degrees to the left.
Make sure that you have to fold **down** to the left.

13

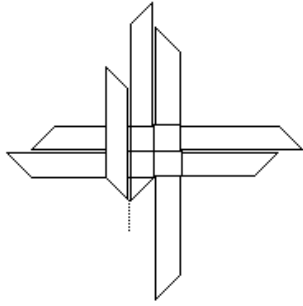

Fold the same strip up with a turn through 90 degrees.

14

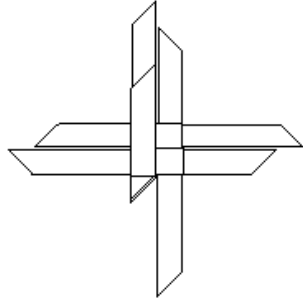

Put the strip upon the both left squares. The first point of the star is nearly ready.

15

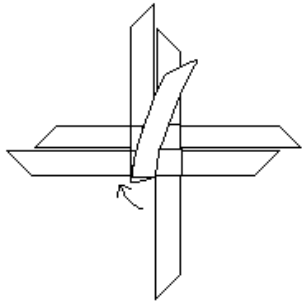

Bend down the point since it is vertical to the four squares.

16

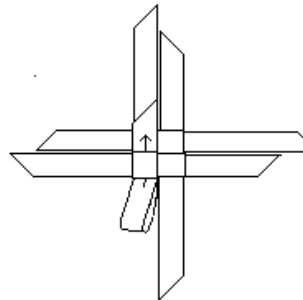

Stick the free end of the strip, which belongs to the point, under the small square on the bottom left.

17

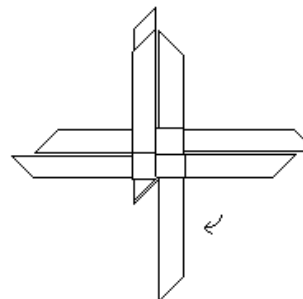

Pull the free end of the strip up in one go.

18

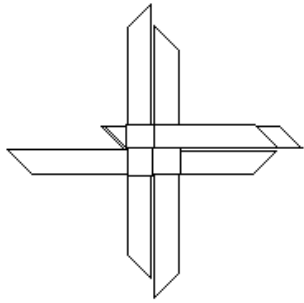

19

Turn the unfinished star through 90 degrees clockwise.
The strip for the next point is waiting at the same place as before.

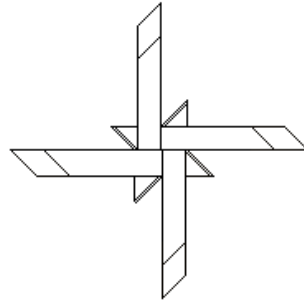

20

Fold the second point.
Turn through 90 degrees clockwise again and make the third point.
Turn and make the fourth point in the same way.

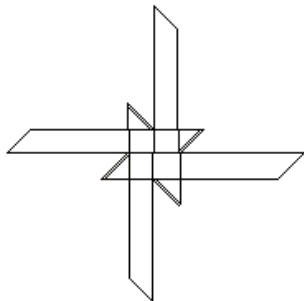

21

Turn around the unfinished star. The reverse side is in front now.

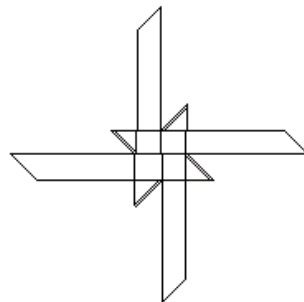

The Eight Bags [top](#)

22

Fold the last four points in the same way as before.

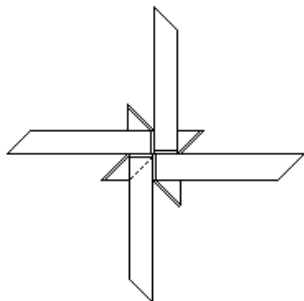

23

Fold the four free ends of the strips in the opposite directions. The strips must come out in the middle and must hang free.

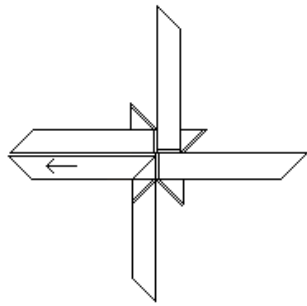

Fold the strip down left to the left. Turn the strip through 90 degrees.

24

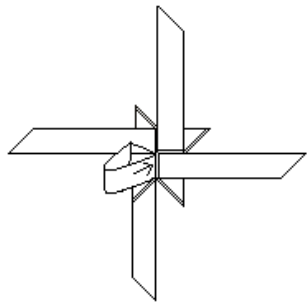

Put the strip upright, so that it is vertical to the squares.
Stick its end under the neighbouring strip.
Make sure that the side of the strip, which points to the top, is also on top if you stick it in.

25

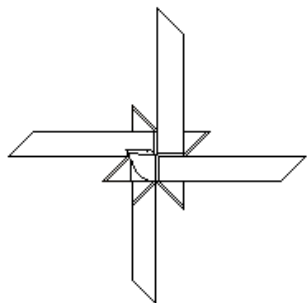

Push the free end of the strip further. It appears at the point down on the right between the two triangles, which form the point.
Pull the free end of the strip and form a bag with your fingers.

26

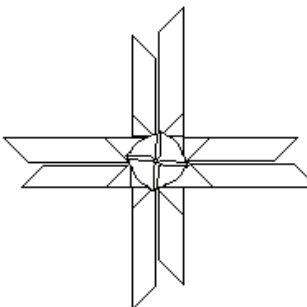

Make the remaining seven bags in the same way.
Cut off the ends of the strips at the points.

27



The star is finished :-).

Variants of the Froebel Star [top](#)

1. You can stop after step 21 and leave out the bags.
2. You can fold the star as small as possible.
3. You can leave step 23. Then you don't get pointed bags but more bows.
4. You can use different materials like paper, silk, aluminium foil or plastics.

5. The strips can have different colours, also on both sides. You can colour the strips or the finished star.
6. You can dip the star in fluid wax and/or cover it with glitter. You can fix the glitter with hair setting lotion.
7. In the shop of the Kreuzkirche at Dresden I saw, that the stars can have a tail. Don't cut two strips.
8. Don't cut the strip ends and connect stars with them to get pairs or star rosettes.
9. You can form mobiles with stars.

I like the simple one-colour-star best.

This is a suggestion, how to make a rosette with shortened strips.

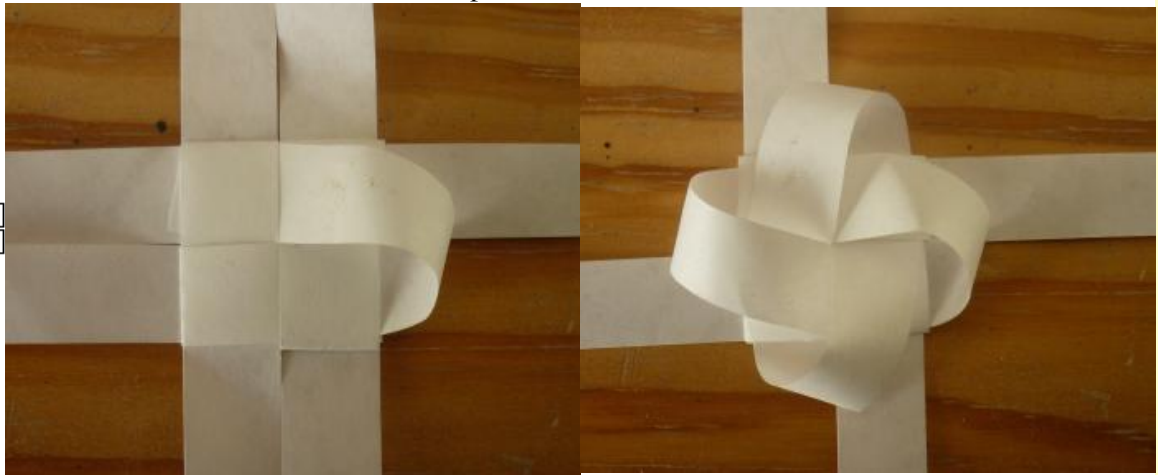
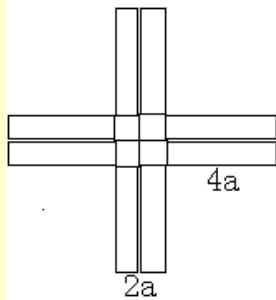

Froebel Star on the Internet [top](#)

German

Fröbelschule Kiel

[Der Fröbelstern](#)

Hildegard Geisler / Ralph Sonntag

[Empfehlung und Bastelanleitung](#)

Markus Götz

[Die wahrscheinlich kleinsten Papiersterne der Welt](#)

NN (Humboldt-Universität zu Berlin)

[Der Fröbelstern](#) (Video)

Sabine Viertel (treffpunkt-ostsee.de)

[Weihnachtsstern - Fröbelstern basteln](#)

Ursula Meiß (Ursulas Kreativ-Insel)

[Anleitung Fröbelstern](#)

Wikipedia

[Fröbelstern](#)

Youtube (videos)

[Fröbelstern falten](#), [fröbelstern](#)

English

craftideas

[How to Make a German Paper Star](#)

David Lister Grimsby

[The Swedish Star, Froebel](#)

Maddy and Maverick
[3-D Stars - Free Instructions](#)

Matt and Elaine Vardjan
[Pennsylvania German Folk Art Papers](#)

Nagledesign
[How to make stars](#)

NN
[Folded Paper German Star Video Tutorial](#) (Video)

Origamisan
[Ribbon Folding, Fish](#) (In Germany known as Fröbelfisch)

WikiHow
[How to Make a German "ribbon" Star](#)

Wikipedia
[Froebel star](#)

Youtube (Videos)
[Origami Froebel star by Froebel Friedrich](#)
[3D Paper Stars Part 1 highhopes no. 7](#), [3D Paper Stars Part 2 highhopes no. 8](#)
[Small paper bow](#)

References (German) [top](#)

- (1) Walter Diem: Sterne, Sterne, Weihnachtssterne, Augsburg 1995
- (2) BURDA, Weihnachtsbasteln, E466, Offenburg 1979
- (3) Kunihiro Kasahara, Origami ohne Grenzen, München 2001 (ISBN 3-8043-0687-X)

Comments [top](#)

- In Germany the star is called Fröbelstern. In the English-speaking world there is no common name. I found German Star, Swedish Star, Polish Star, Danish Star, Pennsylvanian Star, Advent Star, Moravian Star, and (!) Froebel Star.

- Friedrich Fröbel (1782-1852) was one of the founders of the kindergarten movement. He used for instance children's play instinct for plaiting and folding works to give them an understanding of mathematics. So the name of the star is appropriate.

I found out that the name Fröbelstern first arose in the 1960s. But I am not sure.

I know the star by the "Bodenschwingschen Anstalten" at Bethel near Bielefeld. They sent three or four stars to those as a Christmas present, who collected used stamps for them during the year. (The "Bodenschwingschen Anstalten" is a home of mentally disturbed people. They still collect stamps. Please support them.)

-An extract of a description of folding the star from 1891 follows.

It was kindly given to me by *Origami Deutschland* (<http://www.papierfalten.de/>).

Des Kindes erstes Beschäftigungsbuch.

Praktische Anleitung
zur Selbstbeschäftigung für jüngere Kinder.

Zugleich für die Hand
der
Mutter und Kindergärtnerin.

Von
E. Barth und W. Niederley.

Mit zahlreichen Abbildungen und vier farbigen Tafeln.

Vorkurse zu „des deutschen Knaben Handwerksbuch.“

Vierte Auflage.



Miefefeld und Leipzig.
Verlag von Velhagen & Klasing.
1891.

herstellen, dagegen muß die Arbeit bei Herstellung der vier übrigen Spitzen umgewendet werden.

Dies sind die acht Spitzen am Rande, und es sollen nun noch acht Stück tütenförmiger Spitzen, auf jeder flachen Seite des Vierecks vier, angefertigt werden. Abb. 21 D zeigt die Form, welche entsteht,



Abb. 21 E.

wenn die Randspitzen fertig sind. Dieselbe soll jetzt recht gut in Ordnung gebracht werden, d. h. die aus der Mitte herauskommenden vier Streifen sollen so liegen, wie sie natürlich fallen, ohne nach irgend welcher Seite umgebrochen zu sein. Hierauf wird der Streifen b (Abb. 21 D) nach a herübergebrochen, so daß die Form Abb. 21 E entsteht, bei welcher nun der Streifen a mit der Spitze dergestalt unter b zu schieben ist, daß er erstens nicht verdreht wird und zweitens, daß er aus der dort befindlichen Randspitze hervorgezogen werden kann. Vor einem Verdrehen des Streifens a beim Hindurchstecken schützt man sich am besten so, daß man sich

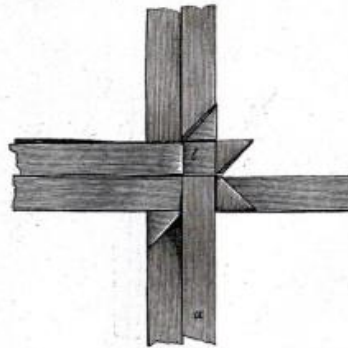

Abb. 21 F.

da, wo in der Abbildung der Buchstabe a steht, ein Zeichen macht und darauf achtet, daß dieses Zeichen stets oben bleibt. Sobald nach dem Hindurchstecken des Streifens a das Ende an der betreffenden Randspitze erscheint, wird daran vorsichtig gezogen, worauf die tütenförmige Spitze auf der Mitte entsteht, wie Abb. 21 F zeigt. Für das weitere Arbeiten ist es nötig, darauf aufmerksam zu machen, daß die tütenförmige Spitze schräg nach b geneigt ist, an welcher Stelle auch der nächste, also der

They told me that the star was known before Fröbel and that Fröbel knew it. The name was given by someone later.

- Today the star has a large circulation in Germany, but not many people can fold it. You can buy it in shops for 1.50 € to decorate your Christmas tree.

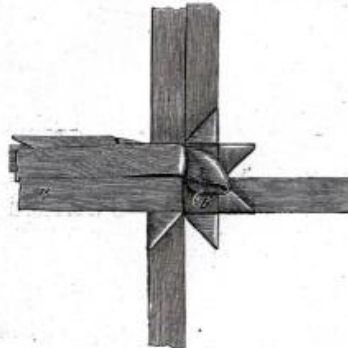
- You make the strips best with a cutting tool or you take ribbons used in gift-wrapping.

Feedback: Email address on my main page

This page is also available in [German](#).

URL of my Homepage:
<http://www.mathematische-basteleien.de/>

© 1999 Jürgen Köller

[top](#)